

TC950 - Inbuilt Wood Fireplace

Information Sheet for Builders and Architects

FIRE BY **escea.**

SPECIFICATIONS

Est. Heating Area	150-220m ²
Efficiency	61.9%
Average Particulate Emission	1.00g/kg
Appliance Weight/ZCK Weight	185kg/103kg (combined weight = 288kg)
Fuel Type	Hardwood (AU) or Softwood (NZ)
Maximum Log Size	750mm
Authorisation Number	0620-2021a
Compliance	Clearance tested to AS/NZS 2918:2018
Power Requirement	3 Pin 10A 240V power supply
Damper Control	Yes - top right of the appliance
Flue Type	Natural Draught - Direct Vent †
Flue Size	150mm Inner/200mm Outer/250mm outer
Flue Length (minimum)	4.5m - from the top of the appliance
Floor Protector	Required



Combustion Air Intake	External
Heat Shield	Not required
Glass Wash	Yes
Fire Bricks	Vermiculite
Convection Fan	Yes - Thermostatically Controlled
Room Ventilation	See Ventilation section over page
Wetback	Prohibited

† Please refer to Indoor Wood Flue Specification Guide for further guidance. www.escea.com/technical

CAVITY INSTALLATION OPTION



1 Select fireplace location and obtain flue centreline to ensure the flue run is clear from obstructions. Provide an electrical supply adjacent, with an isolation switch outside the cavity. Build the framework to the required dimensions and provide the Zero Clearance Kit vent inlet to the exterior.

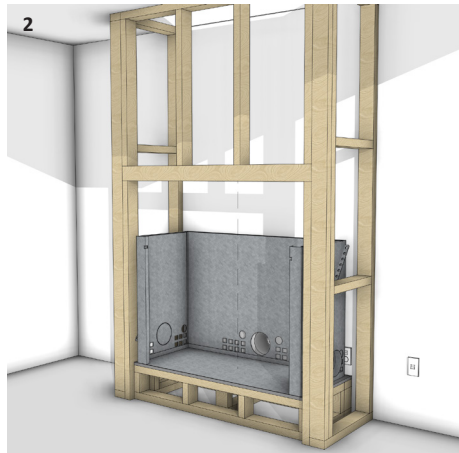

2 Install the structural base for the fireplace **40mm** behind the face of the timber framing. Build the sides, base and rear of the Zero Clearance Kit and install into the cavity.

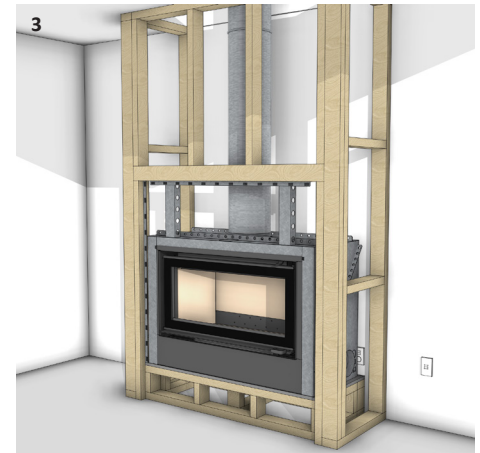

3 Install the fireplace onto a base or structure following the TC950 Installation Manual. Restrain the fire to its base. Fit the top panel and standoffs for the Zero Clearance Kit. Install the Skamotec fixing brackets to the perimeter of the cavity opening.

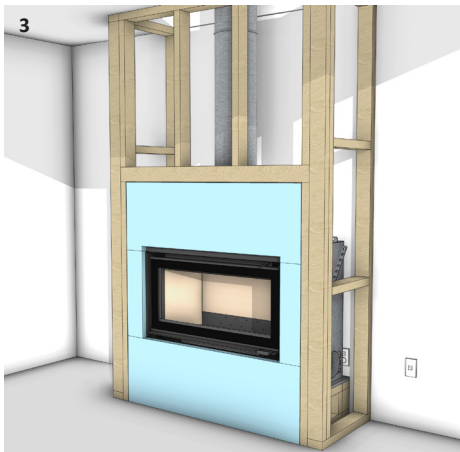

4 Install the flue and liners to the correct configuration and height. Cut, prime, and fix the Skamotec panels in place.

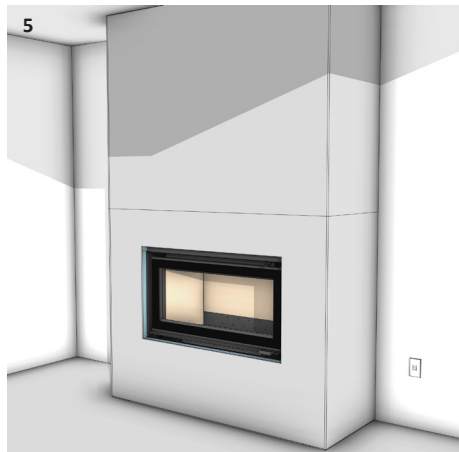

5 Fix the non-combustible fibre cement sheet substrate to the framework. All substrates, wall linings and finishes to the front face of the cavity must be non-combustible.

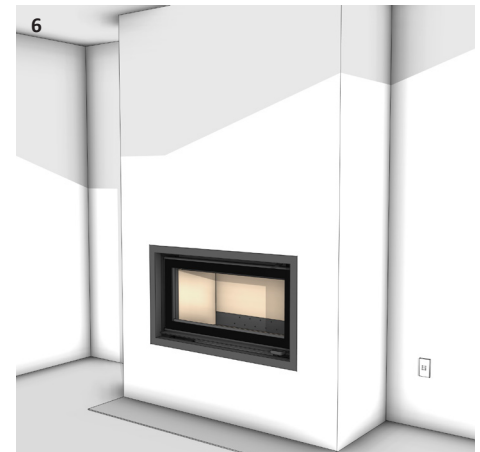

6 Complete the installation by installing the remaining fireplace components, apply any finishes to the walls, and install the floor protector or hearth.

TC950 - Inbuilt Wood Fireplace

Information Sheet for Builders and Architects

FIRE BY **escea.**

APPLIANCE DIMENSIONS

Appliance Width (A)	1050mm
Appliance Height (B)	745mm
Appliance Depth (C)	443mm
Zero Clearance Kit Width (D)	1260mm
Zero Clearance Kit Height (E)	1143mm
Zero Clearance Kit Depth (F)	530mm
Viewing Area	987mm W x 528mm H
Door Handle Height off Base	235mm
Firebox Opening Height off Base	190mm
Floor Protector Size	1380mm W x 300mm D

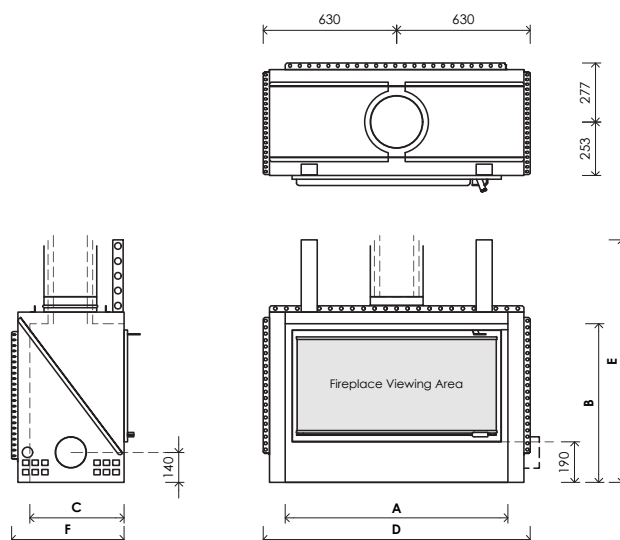

FIREPLACE BASE AND FLOOR PROTECTOR

The TC950 Fireplace must be installed at least 235mm above the finished level of a combustible surface, with a continuous base capable of supporting the appliance and flue system. For installations where the base is at least 235mm above a combustible floor, a non-combustible, heat-resistant floor protector measuring 1380mm W x 300mm D, extending from the fireplace opening, is required. To reduce the 235mm clearance, an insulating, heat-resistant hearth compliant with AS/NZS 2918 can be used.

FINISHING

The TC950 Fireplace, you have two finish options. The choice between a finishing trim or fascia depends on your wall finish or cladding.

Frameless Trim: Ideal for non-combustible and heat-resistant finishes that extend beyond the trim's face.

Linear Fascia: Designed for monolithic, painted, or plaster finishes. This fascia overlaps the wall finish at the fireplace opening.

All materials, boards, and finishes on the front face of the cavity must be entirely non-combustible and heat-resistant.

*Refer to the TC950 Finish Details for further information: www.escea.com/technical

CAVITY CLEARANCES

Cavity Opening Width min. (A)	1265mm
Cavity Opening Height min. (B)	1378mm
Cavity Opening Depth min. (C)	580mm
Overall Cavity Height (D)	1265mm
Adjacent Side Wall Clearance min. (E*)	500mm
Convection Air Intake Hole (F)	345mm

For TC950 Fireplace installation in combustible cavities or structures, the Zero Clearance Kit is required to ensure safety around adjacent combustible and heat-sensitive materials, including timber-framed walls. To maintain safety, objects in front of the fireplace should be at least 1.2m away, considering material heat tolerance.

The use of HHA approved/accredited tradespeople for installation, is recommended.

*Side wall clearance E is taken from the side of the TC950 fireplace opening.

VENTILATION

Provide ventilation in to the Zero Clearance Kit (ZCK) using one of three methods. The Zero Clearance Kit is vented out via the 250mm outer flue liner.

Option 1 - Direct from outside: Preferred.

Option 2 - Vent from roof space: For single-story buildings with ceilings under 2.7m.

Option 3 - Vent from the room with the fireplace: Less preferred.

*Vent size: 150mm \varnothing hole or 17675mm².

MANTEL AND TV CLEARANCES

Combustible mantels and surrounds are to be 500mm above, and 300mm from sides, with max. depth 100mm from the wall. Non-combustible and heat resistant mantels can be at any height and depth.

A TV or electrical appliance above the TC950 requires a non-combustible mantel extending 300mm from the wall, positioned 420mm above the fire, with a TV protrusion limit of 80mm. Mantel width should exceed the fireplace by 100mm on both sides. TV clearances are suggestions, and Escea cannot guarantee suitability for any electrical appliance above the TC950. Contact an Escea Architectural Advisor for further guidance.

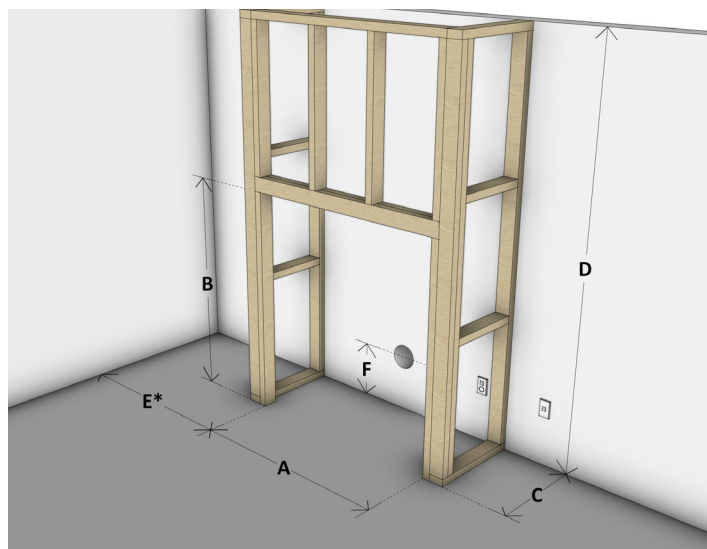

Install in accordance with AS/NZS 2918 and the Escea TC950 Install Manual.

For Installation methods not covered in this document please contact:

Email: aa@escea.com PH (NZ): 0800 17 3000 PH (AU): 1800 460 832

Install Manual and CAD files are available via the QR Code or link:

www.escea.com/technical



Disclaimer:

Dimensions provided are indicative and may not consider all site-specific variations or installation needs. Verify dimensions on-site before manufacturing or construction.